

LEGO

10029

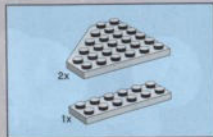

United States

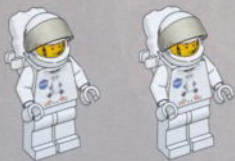
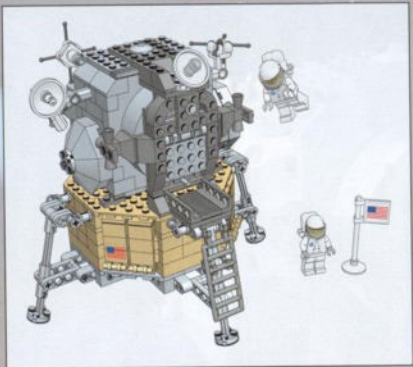
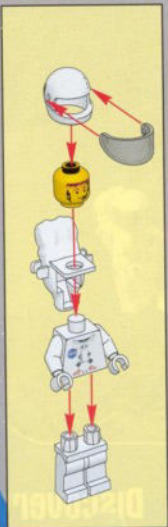

1

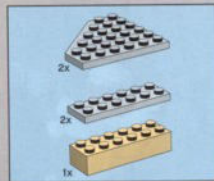
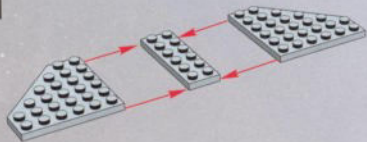

2

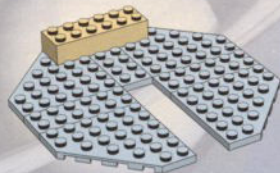

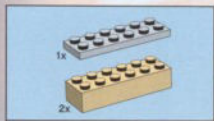

3

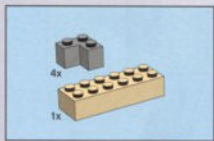
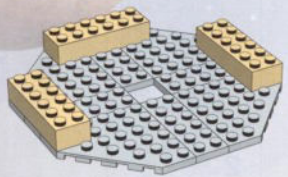

4

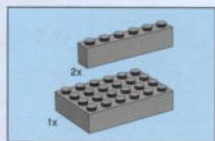
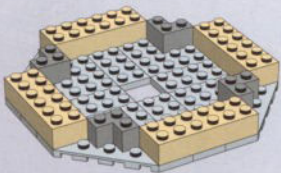

5

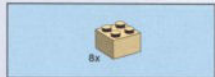
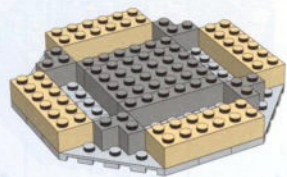

6

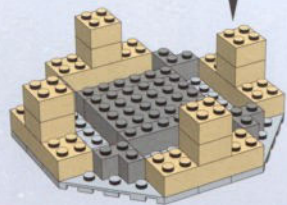
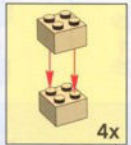

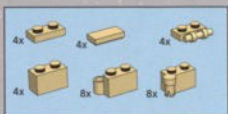

7

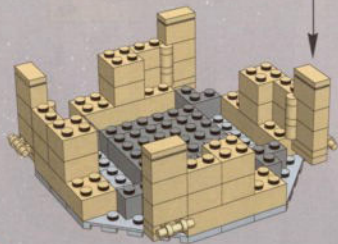
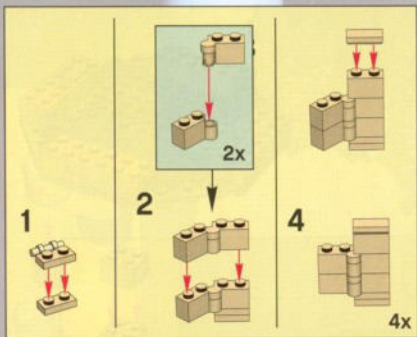

8

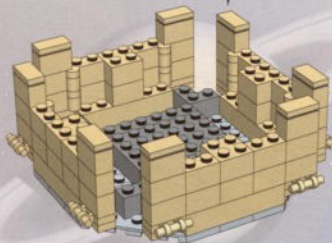
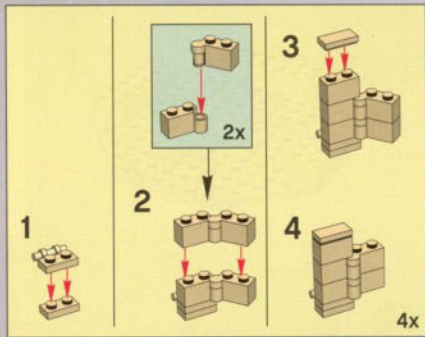
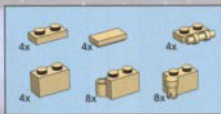

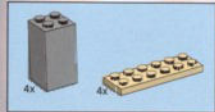

9

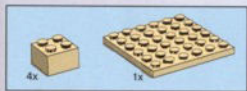
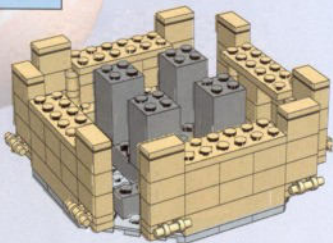

10

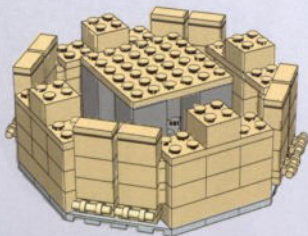

11

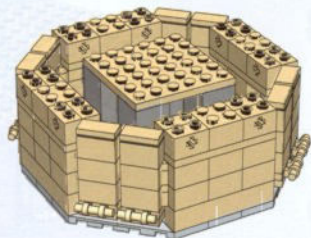

12

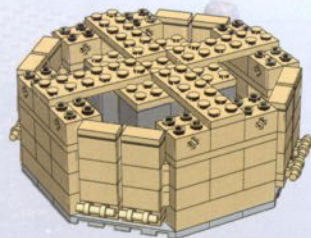



13

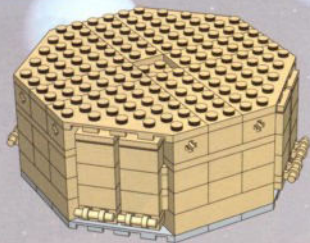

14

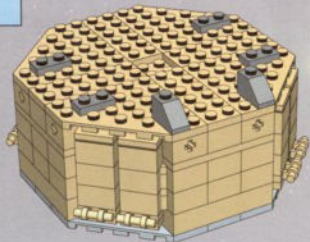

15

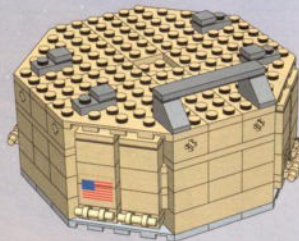

16

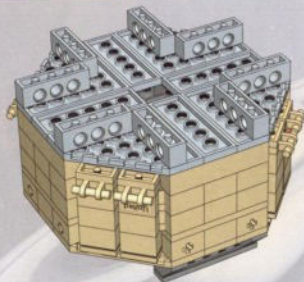



17

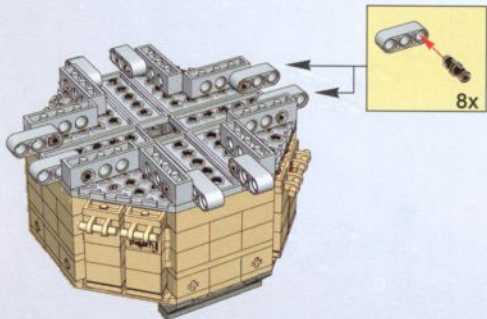

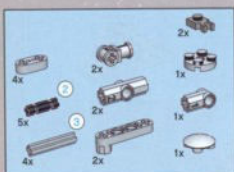

18

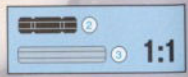
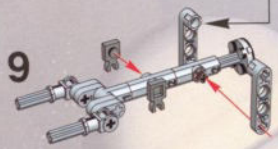
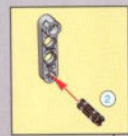
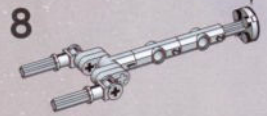
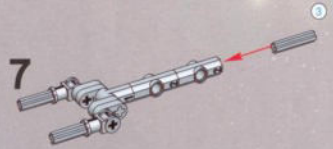
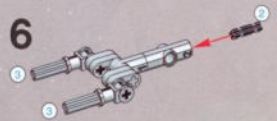
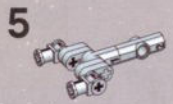

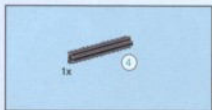

19

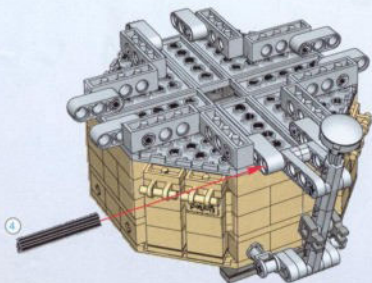
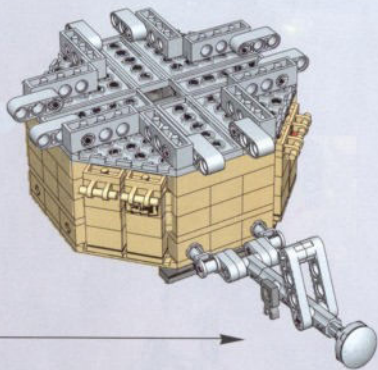

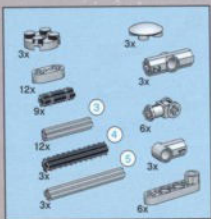



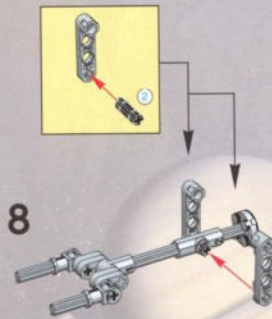
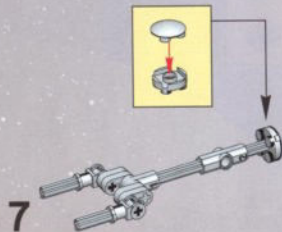

20

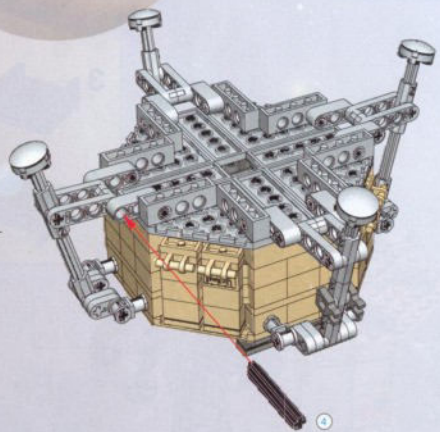

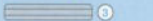

3x



-  2
 -  3
 -  4
 -  6
- 1:1**

-  1x
-  1x
-  1x

21

- 1 
- 2 

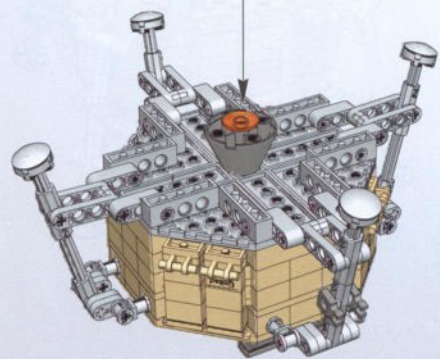



22

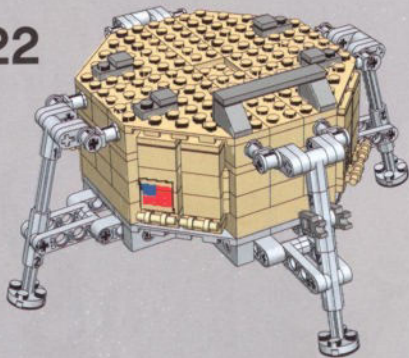

23

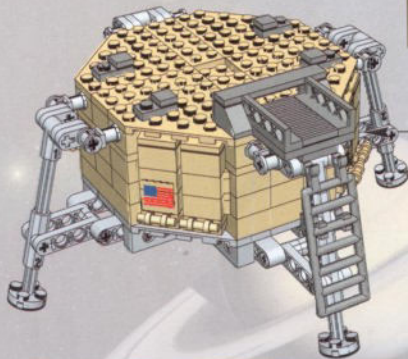
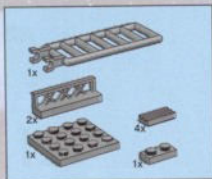

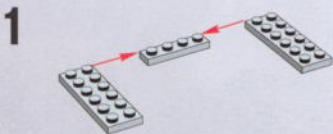
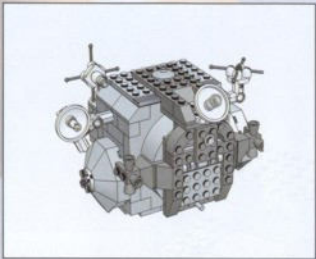

2

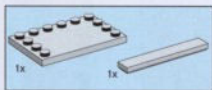
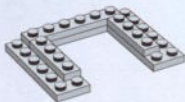

3

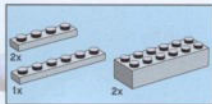

4

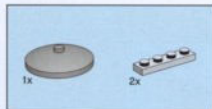

5

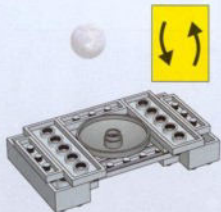

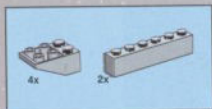

6

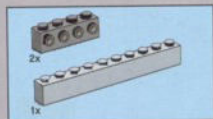
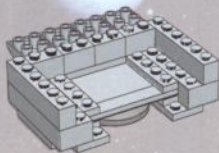

7

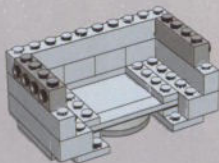

8

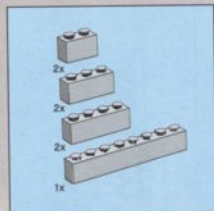
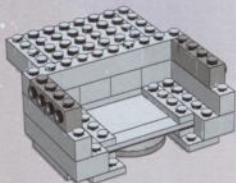

9

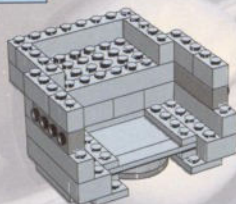

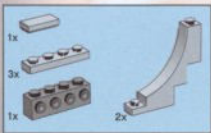

10

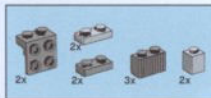
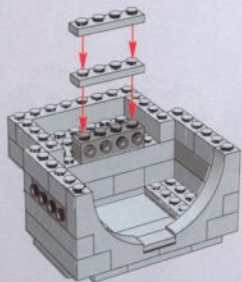
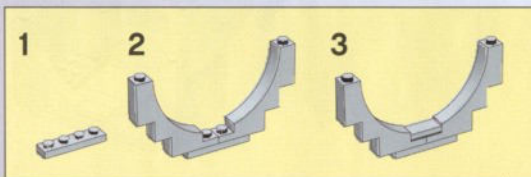

11

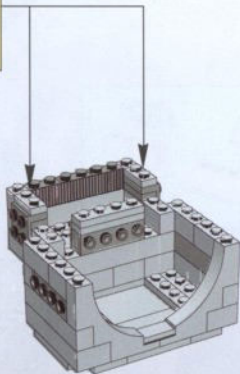
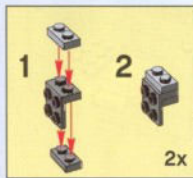



12

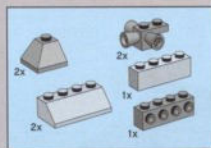
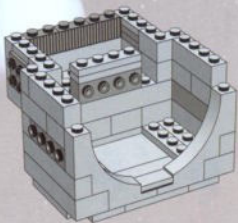

13

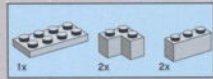
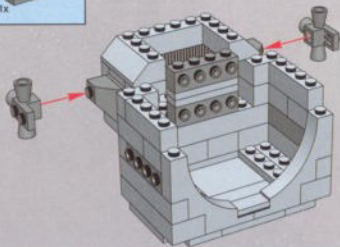

14

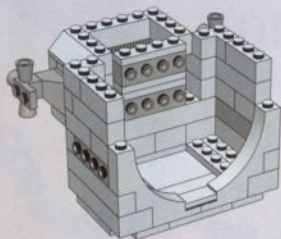

15

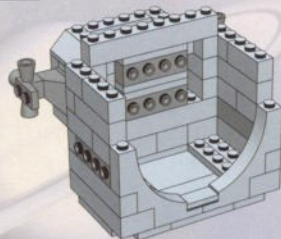

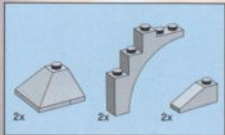

16

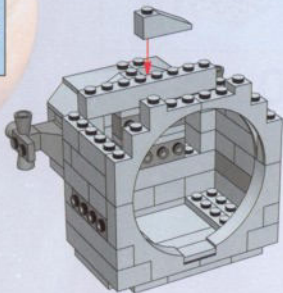

17

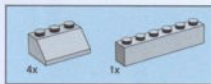
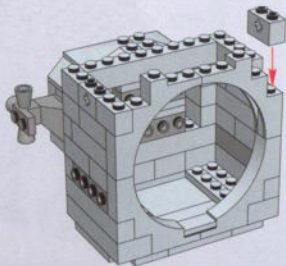

18

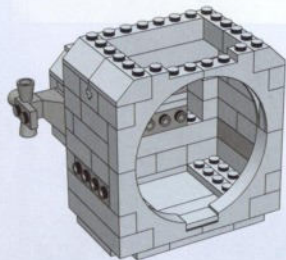

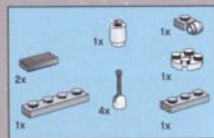

19

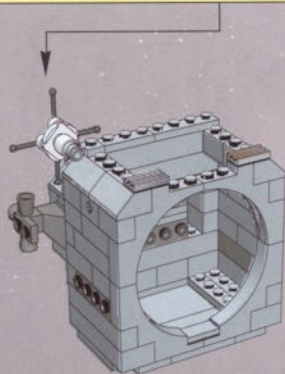
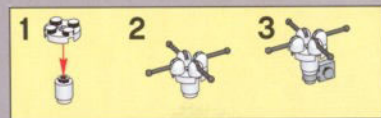

20

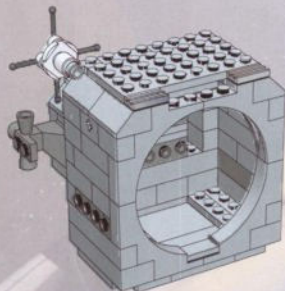

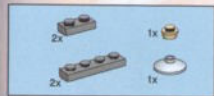

21

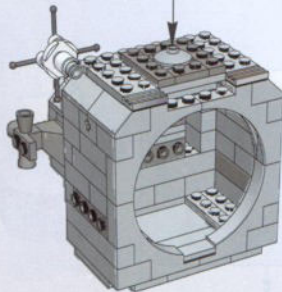

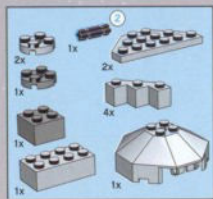

22

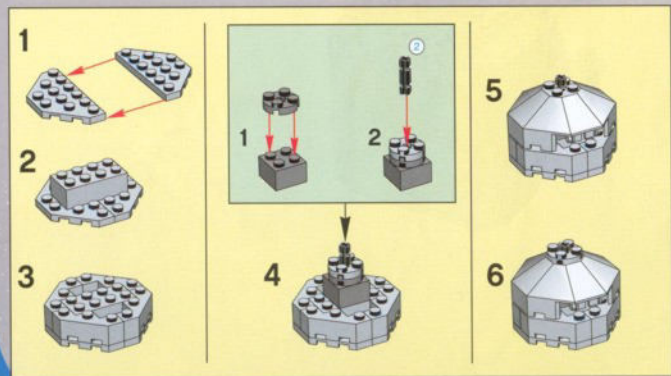
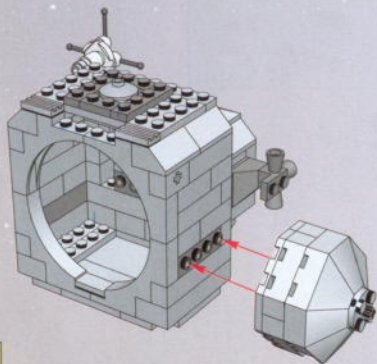



23

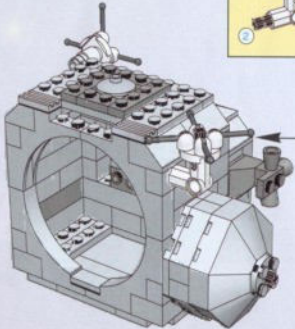
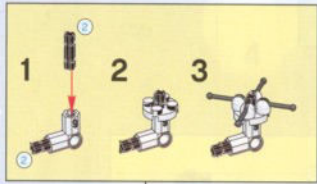

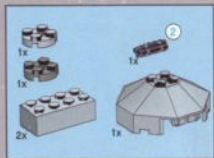

24

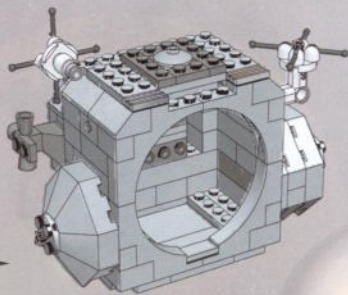
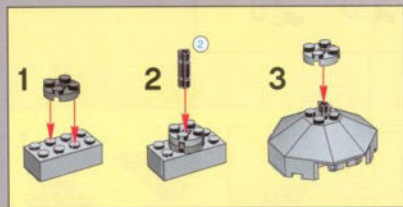

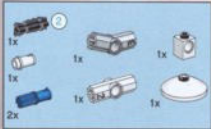

25

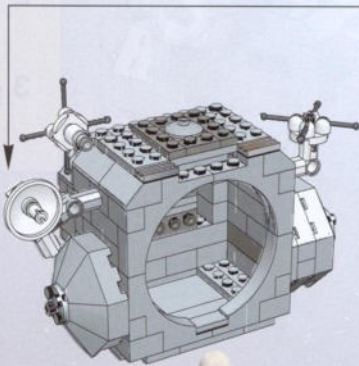
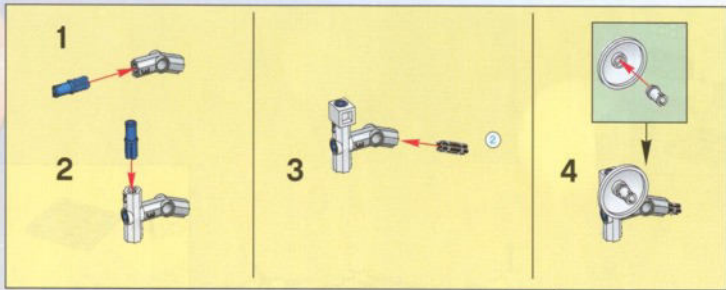



26

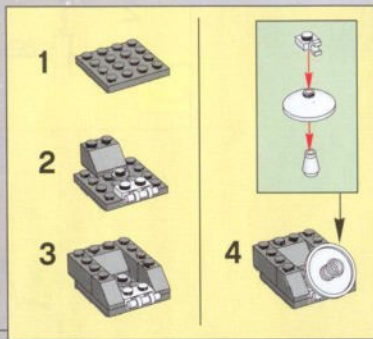
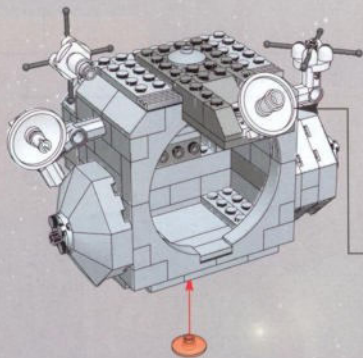



1

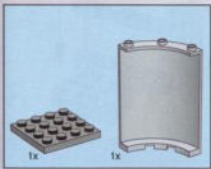
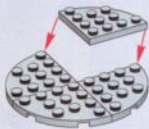

2



3

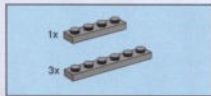

4





5

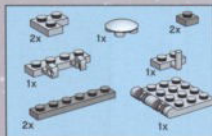
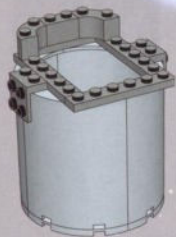

6

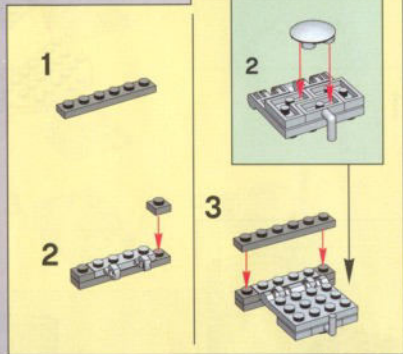

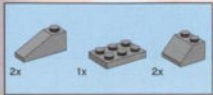

7



8

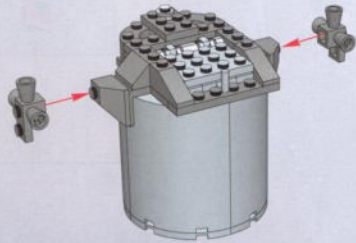

27

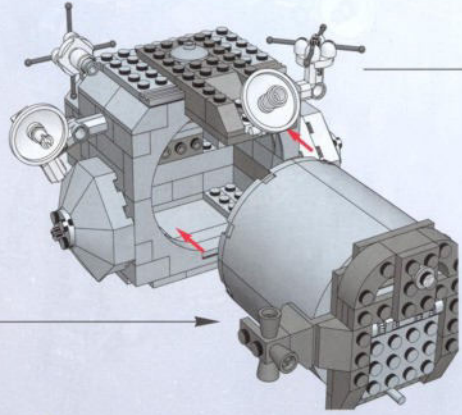



24

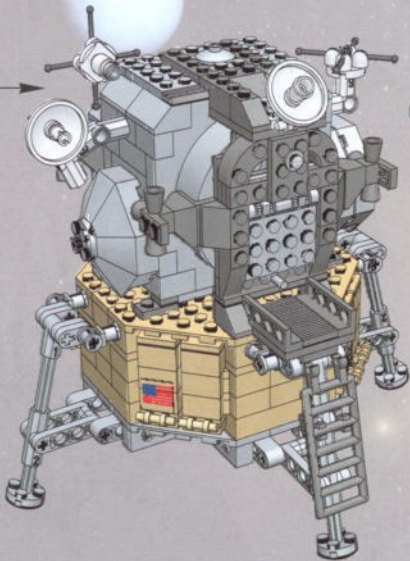

1



2

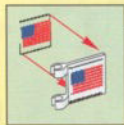



7471 MARS EXPLORATION ROVER



7468 SATURN V MOON MISSION



7469 MISSION TO MARS



7470 SPACE SHUTTLE DISCOVERY



7467 INTERNATIONAL SPACE STATION

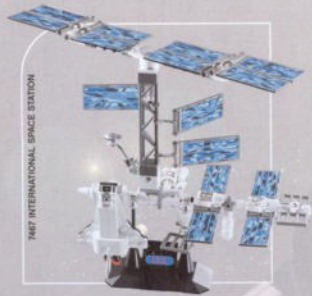

Win! Gagne! Gewinne! 当たります



Win LEGO® products

We would really like to know what you think about your new LEGO® product.

If you could help us by answering a few questions at www.acnielsen.aim.dk/lego then you are in with a chance of winning an exciting LEGO prize.

It will only take you about 3 minutes!



Estimado usuario LEGO®

Al contestar algunas preguntas en inglés, francés, alemán o japonés, en el sitio www.acnielsen.aim.dk/lego, podrás participar en el sorteo de algunos valiosos premios LEGO®.



Gagne des produits LEGO®

Nous aimerions beaucoup savoir ce que tu penses de ton nouveau produit LEGO®.

Si tu veux bien nous aider en répondant à quelques questions sur www.acnielsen.aim.dk/lego, tu recevras peut-être bientôt l'un des nombreux super-prix offerts par LEGO® aux participants.

Et cela ne te prendra que 3 minutes environ !



Kedves Ifjú LEGO® Vásárló

Ha ellátogatsz a www.acnielsen.aim.dk/lego honlapra és ott angol, francia, német vagy japán nyelven megválaszolsz néhány kérdést, akkor részt veszel egy versenyben, amelyben értékes LEGO® díjakat nyerhetsz.



Gewinne LEGO® Produkte

Wir sind sehr an deiner Meinung über dein neues LEGO® Produkt interessiert.

Wenn du uns den Gefallen tust und unter www.acnielsen.aim.dk/lego Fragen beantwortest, kannst du einen tollen LEGO Preis gewinnen.

Das Ganze dauert nur etwa 3 Minuten!



Caro Consumidor da LEGO®

Ao responder a algumas perguntas em inglês, francês, alemão ou japonês no endereço www.acnielsen.aim.dk/lego irá participar num concurso para ganhar valiosos prémios da LEGO®.



抽選でレゴ製品が当たります

私たちは、皆さんがレゴ製品についてどんな感想をお持ちか、是非知りたいと思っています。

www.acnielsen.aim.dk/legoにアクセスいただき、質問にご回答いただきますと、抽選で楽しいレゴ製品が当たります。

アンケートのご回答には、ほんの3分ほどしかかかりません!





 www.LEGO.com

LEGO and the LEGO logo are trademarks of the LEGO Group.
© 2004 LEGO System A/S. All rights reserved. LEGO, the LEGO logo, and the minifigure are trademarks of LEGO System A/S.